

**Brazed Plate
Heat Exchangers
for Fluid Power
Applications**

BPSeries



We **COOL** what you **POWER**

thermaltransfer.com

ttpsales@apiheattransfer.com

BP Series

Our BP Series heat exchangers are rugged, compact, cost-effective and reliable over long periods of time with minimal maintenance – an optimal heat transfer solution for compact industrial applications.

316 stainless steel construction and standard SAE connections are features of this highly efficient technology. The compact design and multiple mounting options lead to optimization of heat transfer when space is limited. High plate channel turbulence means effective performance even with close approach temperatures. Our wide offering of standard models ensures fast delivery worldwide. Custom applications always welcome!

Standard **BPSW** Series:
full featured with short lead time



Made to Order **BPW** Series:
customized solutions



A BP Series heat exchanger is one of the most efficient ways to transfer heat today.

SIZE

Design options for heat transfer applications sensitive to weight and space claim can now include the BP Series.

REDUCED HEAT EXCHANGER FLUID VOLUMES

BP Series units hold a minimal volume of fluids. This feature favorably affects material content and overall system footprint.

MATERIAL BENEFIT

BP Series units are gasket-free allowing approximately 95% of the heat exchanger surface to be in effective contact with fluids

PERFORMANCE

High flow turbulence in plate channels brings the benefit of efficient heat transfer even when hot / cold fluid temperature difference is minimal (close approach temperature).

STANDARD MODELS AND CUSTOMIZED SOLUTIONS

A wide offering of standard BPSW models means short lead times and fast delivery worldwide. Our BPW Series offers customized solutions for your specific applications.

EFFICIENCY ON A GLOBAL SCALE

BP Series units have global applications in demanding, compact applications. Efficient performance is the product of focused research and development activities. 40+ years of engineering experience stands behind all solutions offered by Thermal Transfer Products.

APPROVALS

TTP BP Series heat exchangers are approved by leading independent third-party international bodies:

- **Canada:** Canadian Standard Association (CSA)
- **Japan:** The High Pressure Gas Safety Institute of Japan (KHK)
- **USA:** Underwriters Laboratories (UL)
- **Europe:** Pressure Equipment Directive (PED)

Brazed Plate Heat Exchangers Explained

A brazed plate heat exchanger is constructed as a series of corrugated channel plates stacked between front and rear cover plates. The cover plates can be configured with sealing plates or with blind rings. Connections are mounted on the cover plates and can be customized to meet specific market and application requirements. During the vacuum brazing process, a brazed joint is formed at every contact point between the base and the filler material. This design creates a heat exchanger with two separate channels or circuits.

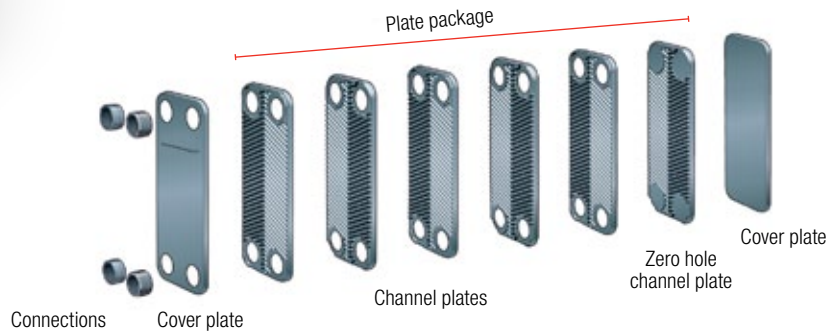

Sealing plates are used to seal off the space between the cover plate and the first and last channel plates. The number of cover plates varies with the type and size of the exchanger and pressure rating. Some brazed plate heat exchangers have a blind ring to seal off the space between the channel plate and the cover plate. In others, the blind rings are integrated in the cover plate and first/last channel plates.

Plates and Channel Types

Brazed plate heat exchangers are also available with optional variation in channel plate corrugation within one unit. This feature can bring benefits to hydraulic and thermal performance. As an example, one heat exchanger can have equal pressure drop for both channels even with different flow rates in each.

Fluids can pass through the heat exchanger in different ways. Flow configurations are either:

- **Counter Flow** - standard plumbing method for typical opposing flow paths
- **Co-Current Flow** - configurable by plumbing for same direction flow paths
- **Multi-Pass Flow** - BPW only, custom plate configuration to allow oil to flow multiple passes in cooler, Ideal for low flow applications

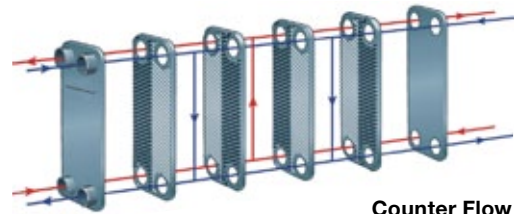

Counter Flow

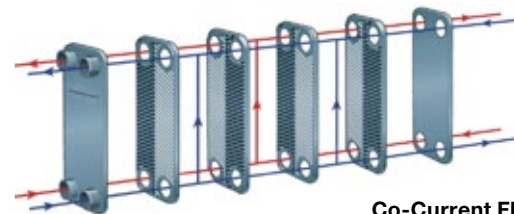

Co-Current Flow

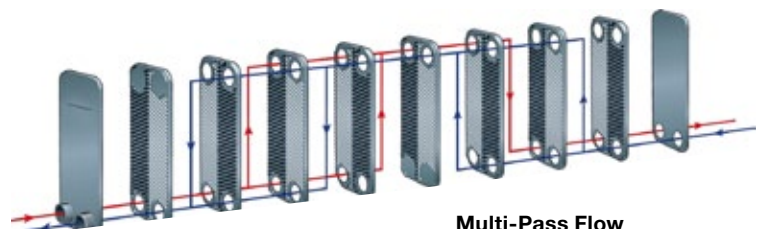

Multi-Pass Flow

BPSW Series - Standard Model

STAINLESS STEEL CONSTRUCTION

Features

- Short Lead Time
- Stacked Plate
- Stainless Steel
- Copper Brazed
- Oil to Water Applications
- High Performance
- Compact Design
- SAE Connections
- Corrosion Resistant Type 316 Stainless Steel Plates
- Mounting Studs Standard (except 8x3 plates)
- SAE Oil Connections, NPT Water Connections
- Optional Foot Mounting Bracket (except 8x3 plates) SEE PAGE 13



Ratings

Maximum Working Pressure 450 psi

Test Pressure 650 psi

Minimum Working Temperature -320°F

Maximum Working Temperature 437°F

Materials

Plate Material - Fluid Contact

316 Stainless Steel

Braze Material Copper

Connectors 316 Stainless Steel

Stud Bolts 304 Stainless Steel

Foot Mounting Bracket Carbon Steel

How to Order



Option

Foot Mounting Brackets
(ordered as a separate item)

Part No.	Plate Size
56839	- 12x5
56840	- 20x5
56841	- 15x5
56842	- 15x10
56843	- 20x10
56844	- 28x10

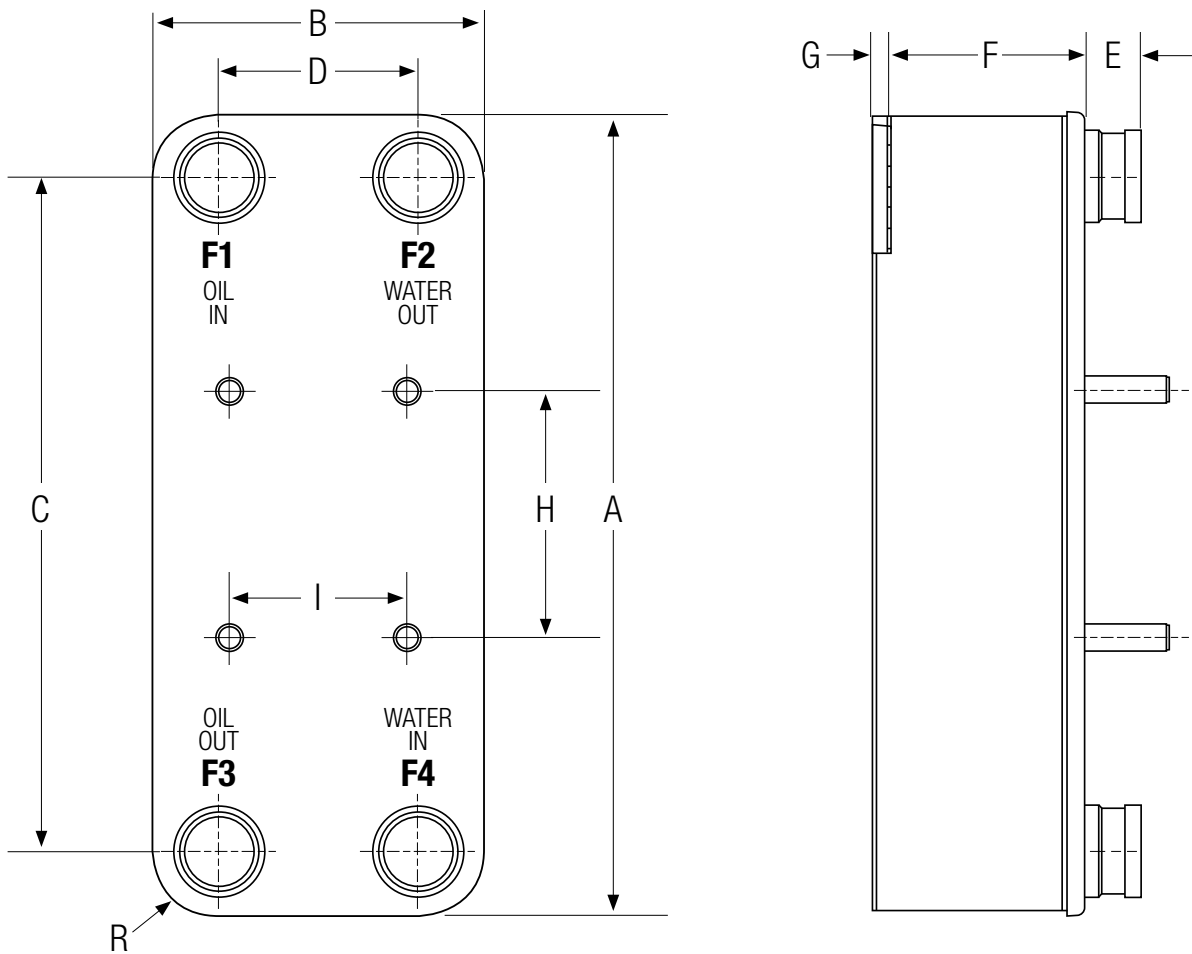

Model	A	B	C	D	E	F	G	F3, F1	F2, F4	H	I	Stud Bolt		R	Net Weight (lbs)
												Thread	Length		
BPSW-10-8x3	7.6	2.98	6.06	1.57	0.79	1.04	0.28	#10 SAE	¾" NPT	NA	NA	NA	NA	0.70	2.05
BPSW-30-8x3	7.6	2.98	6.06	1.57	0.79	2.80	0.28	#10 SAE	¾" NPT	NA	NA	NA	NA	0.70	3.99
BPSW-12-12x5	11.4	4.69	9.57	2.83	1.78	1.21	0.24	#12 SAE	¾" NPT	5.51	2.36	M8	0.76	0.90	5.60
BPSW-24-12x5	11.4	4.69	9.57	2.83	1.78	2.27	0.24	#12 SAE	¾" NPT	5.51	2.36	M8	0.76	0.90	8.14
BPSW-36-12x5	11.4	4.69	9.57	2.83	1.78	3.33	0.24	#20 SAE	1¼" NPT	5.51	2.36	M8	0.76	0.90	10.68
BPSW-70-12x5	11.4	4.69	9.57	2.83	1.78	6.32	0.24	#20 SAE	1¼" NPT	5.51	2.36	M8	0.76	0.90	17.87
BPSW-50-20x5	20.7	4.69	18.5	2.48	1.07	4.56	0.24	#20 SAE	1¼" NPT	8.86	2.36	M8	1.19	0.90	23.04
BPSW-70-20x5	20.7	4.69	18.5	2.48	1.07	6.32	0.24	#20 SAE	1¼" NPT	8.86	2.36	M8	1.19	0.90	30.28
BPSW-110-20x5	20.7	4.69	18.5	2.48	1.07	9.84	0.24	#20 SAE	1¼" NPT	8.86	2.36	M8	1.19	0.90	44.74
BPSW-50-15x5	14.8	4.69	12.6	2.48	1.07	4.56	0.24	#20 SAE	1¼" NPT	8.86	2.36	M8	0.79	0.90	17.04
BPSW-90-15x5	14.8	4.69	12.6	2.48	1.07	8.08	0.24	#20 SAE	1¼" NPT	8.86	2.36	M8	0.79	0.90	27.62
BPSW-130-15x10	15.5	9.57	12.76	6.85	1.07	12.28	0.12	#24 SAE	1½" NPT	5.51	3.94	M12	0.75	1.38	112.85
BPSW-200-15x10	15.5	9.57	12.76	6.85	1.07	18.72	0.12	#24 SAE	1½" NPT	5.51	3.94	M12	0.75	1.38	165.32
BPSW-24-20x10	20.7	9.57	17.95	6.85	1.07	2.55	0.16	#24 SAE	1½" NPT	5.51	3.94	M12	1.53	1.38	44.02
BPSW-50-20x10	20.7	9.57	17.95	6.85	1.07	4.89	0.16	#24 SAE	1½" NPT	5.51	3.94	M12	1.53	1.38	67.17
BPSW-80-20x10	20.7	9.57	17.95	6.85	1.07	7.59	0.16	#24 SAE	1½" NPT	5.51	3.94	M12	1.53	1.38	93.89
BPSW-90-28x10	27.3	9.57	23.62	5.83	2.13	8.73	0.04	2½" SAE Flg	2½" NPT	12.13	3.94	M12	1.53	1.89	148.24
BPSW-130-28x10	27.3	9.57	23.62	5.83	2.13	13.11	0.04	2½" SAE Flg	2½" NPT	12.13	3.94	M12	1.53	1.89	198.24

All dimensions are inches, unless noted otherwise.

Note: We reserve the right to make reasonable design changes without notice.

Performance Curves

Low Flow

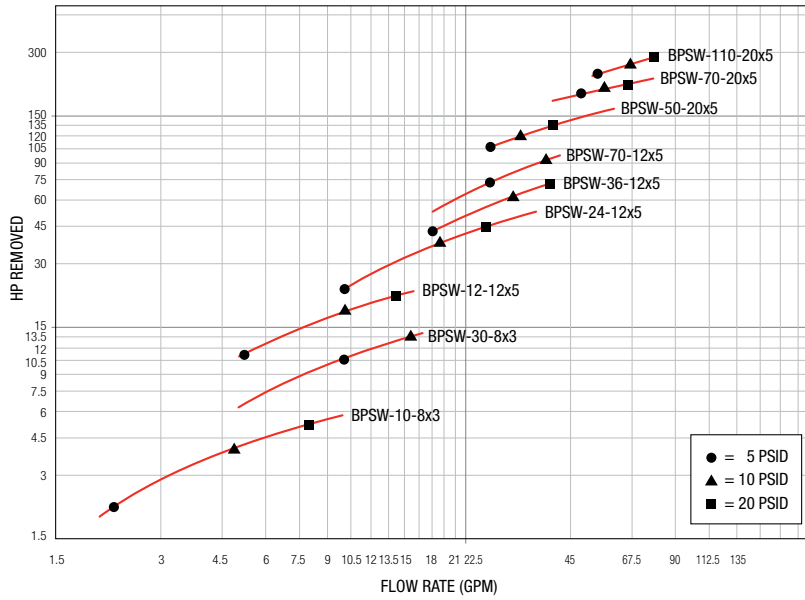

Medium Flow

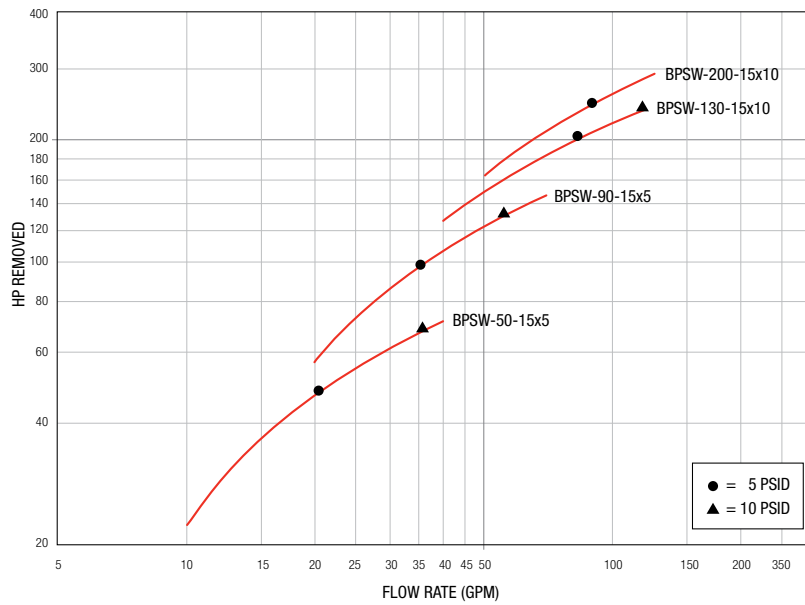

High Flow

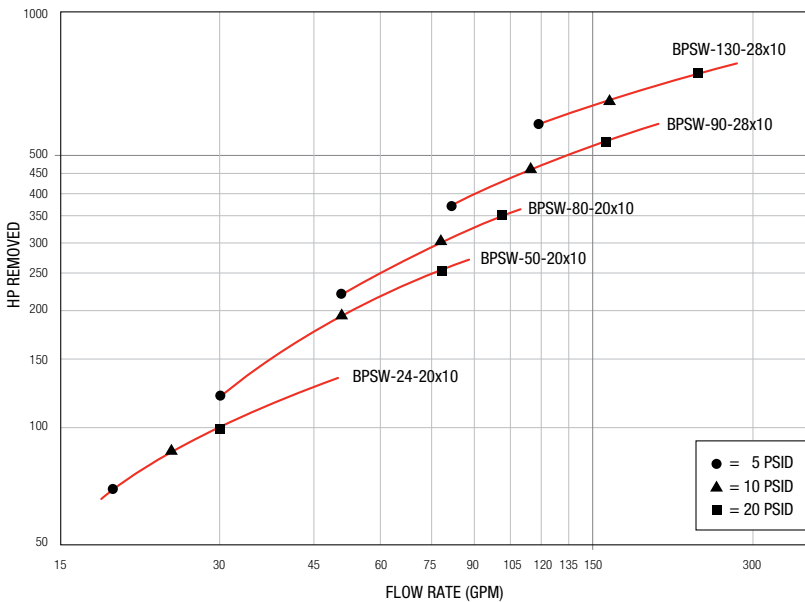

Performance Correction

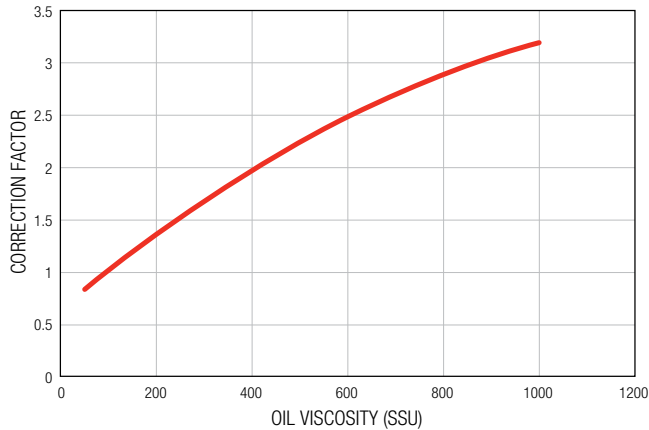

Pressure Drop Correction

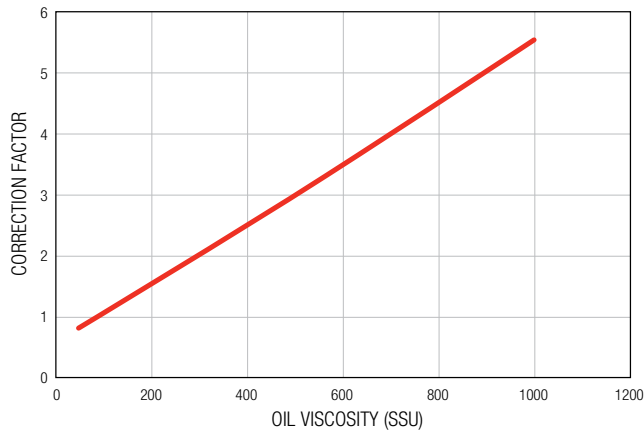

	Model	Oil Conn (Female)	Water Conn (Female)
SMALL FLOW	BPSW-10-8x3	#10 SAE	3/4" NPT
	BPSW-30-8x3	#10 SAE	3/4" NPT
	BPSW-12-12x5	# 12 SAE	3/4" NPT
	BPSW-24-12x5	# 12 SAE	3/4" NPT
	BPSW-36-12x5	#20 SAE	1 1/4" NPT
	BPSW-70-12x5	#20 SAE	1 1/4" NPT
	BPSW-50-20x5	#20 SAE	1 1/4" NPT
	BPSW-70-20x5	#20 SAE	1 1/4" NPT
MEDIUM FLOW	BPSW-110-20x5	#20 SAE	1 1/4" NPT
	BPSW-50-15x5	#20 SAE	1 1/4" NPT
	BPSW-90-15x5	#20 SAE	1 1/4" NPT
	BPSW-130-15x10	#24 SAE	1 1/2" NPT
LARGE FLOW	BPSW-200-15x10	#24 SAE	1 1/2" NPT
	BPSW-24-20x10	#24 SAE	1 1/2" NPT
	BPSW-50-20x10	#24 SAE	1 1/2" NPT
	BPSW-80-20x10	#24 SAE	1 1/2" NPT
	BPSW-90-28x10	2 1/2" SAE FLG	2 1/2" NPT
BPSW-130-28x10	2 1/2" SAE FLG	2 1/2" NPT	

Performance Curves are based on 100SSU oil at 40°F approach temperature (125°F oil leaving cooler, 85°F water entering cooler), 2:1 oil: water ratio (1 GPM water flow for each 2 GPM oil flow).

Step 1 Determine Curve Horsepower Heat to be Removed.

$$\text{Horsepower heat load} \times \frac{40}{\text{Oil leaving cooler } ^\circ\text{F} - \text{minus water entering cooler } ^\circ\text{F}} \times \text{Performance correction multiplier} = \text{Curve horsepower heat to be removed}$$

Step 2 Determine Actual Oil Pressure Drop. Pressure drop shown on curve x Pressure drop correction multiplier = Actual pressure drop.

Oil Temperature

Oil coolers can be selected by using entering or leaving oil temperatures.

Typical operating temperature ranges are:

Hydraulic Motor Oil	110°F - 130°F
Hydrostatic Drive Oil	130°F - 180°F
Lube Oil Circuits	110°F - 130°F
Automatic Transmission Fluid	200°F - 300°F

Desired Reservoir Temperature

Return Line Cooling: Desired temperature is the oil temperature leaving the cooler. This will be the same temperature that will be found in the reservoir.

Off-Line Recirculation Cooling Loop: Desired temperature is the temperature entering the cooler. In this case, the oil temperature change must be determined so that the actual oil leaving temperature can be found. Calculate the oil temperature change (Oil ΔT) with this formula:

$$\text{Oil } \Delta T = (\text{BTU's/Hr.}) / \text{GPM Oil Flow} \times 210.$$

To calculate the oil leaving temperature from the cooler, use this formula:

$$\text{Oil Leaving Temperature} = \text{Oil Entering Temperature} - \text{Oil } \Delta T.$$

This formula may also be used in any application where the only temperature available is the entering oil temperature.

Oil Pressure Drop: Most systems can tolerate a pressure drop through the heat exchanger of 20 to 30 PSI. Excessive pressure drop should be avoided. Care should be taken to limit pressure drop to 5 PSI or less for case drain applications where high back pressure may damage the pump shaft seals.

BPW Series - Made to Order Model

STAINLESS STEEL CONSTRUCTION

Features

- Customizable sizes and options
- Stacked Plate
- Stainless Steel
- Copper Brazed
- High Performance
- Compact Design
- Corrosion Resistant Type 316 Stainless Steel Plates
- Mounting Studs Standard (except 8x3 plates)
- Optional Foot Mounting Bracket (except 8x3 plates) SEE PAGE 13



Ratings

- Maximum Working Pressure** 450 psi
- Test Pressure** 650 psi
- Minimum Working Temperature** -320°F
- Maximum Working Temperature** 437°F at 450 psi

Pressure rating is for copper brazed only. Consult factory for alternatives.

Materials

- Plate Material - Fluid Contact** 316 Stainless Steel
- Braze Material** Copper
Nickel Optional
- Connectors** 316 Stainless Steel
- Stud Bolts** 304 Stainless Steel
- Foot Mounting Bracket** Carbon Steel

How to Order

BPW	-		-		-		-		-		-		
Model Series BPW		Number of Plates		Model Size Selected 8x3 12x5 20x5 15x5 15x10 20x10 28x10		Connection F3		Connection F1		Connection F2		Connection F4	Option Foot Mounting Brackets (ordered as a separate item)

Please see pages 8-9 for all possible connection sizes and types.

Note: Connections on the cooler must all be the same height. Cannot use connections of different heights.

Part No.	Plate Size
56839	- 12x5
56840	- 20x5
56841	- 15x5
56842	- 15x10
56843	- 20x10
56844	- 28x10

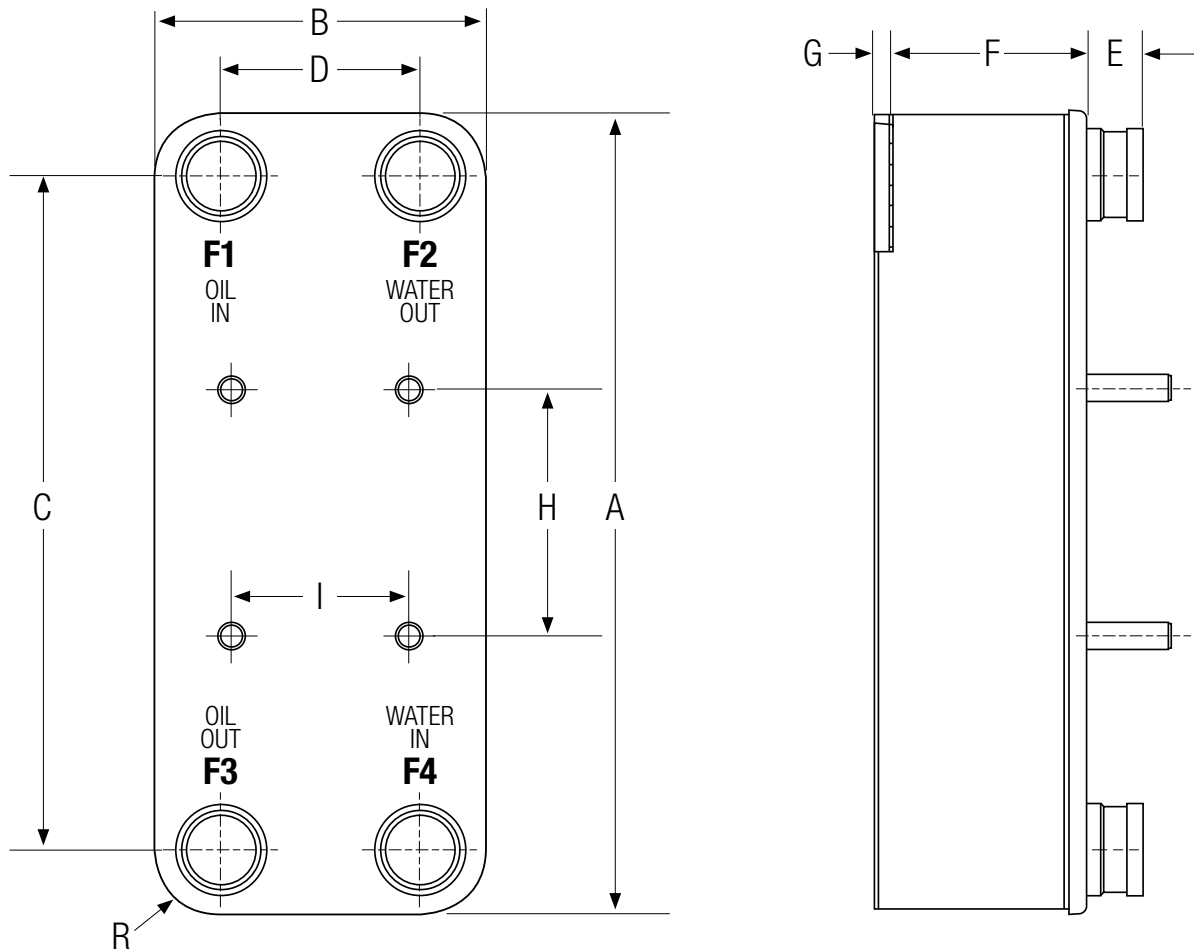

Model	A	B	C	D	E	F	G	H	I	Stud Bolt		R	Approximate Weight (lbs)
										Thread	Length		
BPW-NoP-8x3	7.6	2.98	6.06	1.57	See Connection Tables	$0.157 + 0.088 \times \text{NoP}$	0.28	NA	NA	NA	NA	0.70	$1.082 + 0.097 \times \text{NoP}$
BPW-NoP-12x5	11.4	4.69	9.57	2.83		$0.157 + 0.088 \times \text{NoP}$	0.24	5.51	2.36	M8	0.79	0.90	$3.058 + 0.21 \times \text{NoP}$
BPW-NoP-20x5	20.7	4.69	18.50	2.48		$0.157 + 0.088 \times \text{NoP}$	0.24	8.86	2.36	M8	1.19	0.90	$4.967 + 0.362 \times \text{NoP}$
BPW-NoP-15x5	14.8	4.69	12.60	2.48		$0.157 + 0.088 \times \text{NoP}$	0.24	8.86	2.36	M8	0.79	0.90	$3.814 + 0.265 \times \text{NoP}$
BPW-NoP-15x10	15.5	9.57	12.76	6.85		$0.315 + 0.092 \times \text{NoP}$	0.12	5.51	3.94	M12	0.75	1.38	$15.41 + 0.75 \times \text{NoP}$
BPW-NoP-20x10	20.7	9.57	17.95	6.85		$0.394 + 0.090 \times \text{NoP}$	0.16	5.51	3.94	M12	1.53	1.38	$22.641 + 0.891 \times \text{NoP}$
BPW-NoP-28x10	27.3	9.57	23.54	5.83		$0.630 + 0.096 \times \text{NoP}$	0.04	12.13	3.94	M12	1.53	1.89	$35.741 + 1.25 \times \text{NoP}$

NoP = Number of Plates

All dimensions are inches, unless noted otherwise.

Note: We reserve the right to make reasonable design changes without notice.

Connection Options

Model	Connection Types	Size	Height (E)
BPW-NoP-8x3	SAE	¾" O-Ring	0.79
	Solder	8.2	0.79
		12.2	0.79
		10	0.79
		15.9	0.79
		12.8	0.79
		16	0.79
		22	0.79
		ISO-G	½"
	¾"		0.79
	¾"		0.79
	ISO-G INT Hex	½"	0.79
		¾"	0.79
	UNF	⅝"	0.79
		¾"	0.79
	NPT	½" INT	0.79
		⅝" INT	0.79
		¾" INT	0.79
		½" (M)	0.79
		¾" (M)	0.79
¾" & 16 (Combo M)		0.79	
1" (M)		0.79	
BPW-NoP-12x5	SAE	1" O-Ring	1.06
		1¼" O-Ring (Setting Up)	1.06
	Solder	12.8	0.79
		16	0.79
		22U	0.79
		28U	0.79
		35.1	0.79
	UNF	¾"	0.79
		⅝"	0.79
	NPT	1" INT	1.06
		1" (M)	1.77
		½" INT	0.79
¾" (M)		0.79	
BPW-NoP-15x5	SAE	¼" O-Ring	1.06
	Solder	6.5	1.06
		35.1	1.77
		42U	1.06
		28U	1.06
		12.8	1.06
		16	1.06
		ISO-G	1¼" INT
	1¼" INT HEX		1.06
	½" (M)		1.06
	1¼" (M)		1.77
	1" (M)		1.06
	1½"		1.06
NPT	½" INT	1.06	
	1¼" (M)	1.06	
	1¼" INT (F)	1.77	

Model	Connection Types	Size	Height (E)
BPW-NoP-20x5	SAE	1¼" O-Ring	1.06
	Solder	6.5	1.06
		35.1	1.77
		42U	1.06
		12.8	1.06
		28U	1.06
		22U	1.06
		16	1.06
		ISO-G	1¼" INT
	1¼" INT HEX		1.06
	½"		1.06
	1¼" (M)		1.77
	1"		1.06
	1½" (M)		1.77
	NPT	1" INT HEX	1.06
		½" INT	1.06
		1¼" (M)	1.06
		1¼" INT (F)	1.77
		1" INT (F)	1.77
	Victaulic	1¼" INT (F)	1.77
1¼" (M)		1.77	
1½"		1.06	
1¼" (M)		1.06	
1 ½"		1.77	
1 ½"		1.77	
BPW-NoP-15x10	SAE	1½" O-Ring	1.06
	Solder	16	1.06
		54.3	1.06
		12.8	1.06
		22U	1.06
		28U	1.06
		35.1	1.06
		42U	1.06
		ISO-G	1½"
	NPT	2" (M)	1.06
		1½" (M)	1.06
		1½" INT (F)	1.06
		¾" INT (F)	1.06
	Victaulic	1½"	1.06
		2"	1.06
2"		2.13	
2½"		2.13	

All dimensions are in inches, unless noted otherwise.

Note: Connections on the cooler must all be the same height. Cannot use connections of different heights.

Model	Connection Types	Size	Height (E)
BPW-NoP-20x10	SAE	1½" O-Ring	1.06
	Solder	16	1.06
		54.3	1.06
		12.8	1.06
		22U	1.06
		28U	1.06
		35.1	1.06
	ISO-G	1½"	1.77
	NPT	1½" (M)	1.06
		1½" INT (F)	1.06
		2" (M)	1.06
	Victaulic	1½"	1.06
2"		1.06	
2"		2.13	
2½"		2.13	
BPW-NoP-28x10	SAE	Flange connection is set up	2.13
	Solder	54.3	2.13
		70U	2.13
		42U	2.13
		66.85	2.13
		35.1	2.13
		76U	2.13
	ISO-G	2"	2.13
		2½"	2.13
		3"	2.13
	NPT	2½" (M)	2.13
		2½" INT (F) is setup	2.13
	SAE Flange	2½"	1.18
		3"	1.18
		1½" Round	1.18
		2" Round	1.18
	DIN Compact Flange	DN65C cs	2.13
		DN80C cd	2.13

All dimensions are in inches, unless noted otherwise.

Note: Connections on the cooler must all be the same height. Cannot use connections of different heights.

Optional Connection Types

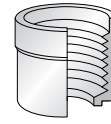

Internally threaded (female)

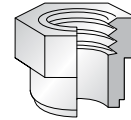

Internally threaded (female) with Hexagonal exterior

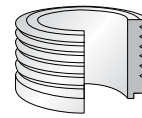

Externally threaded (male)

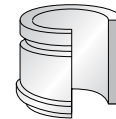

Victaulic

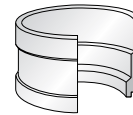

Solder

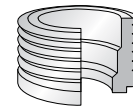

Combo

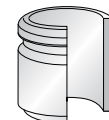

Welding

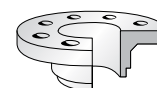

Flanges of DIN/DNC Type

Plate Limits

Model	Number of Plates	HP Removed	Max Oil Flow GPM
BPW-NoP-8x3	10	2	2
	20	4	4
	30	8	6
	40	11	8
	50	16	12
	60	22	16
	70	26	18
	80	27	18.5
BPW-NoP-12x5	10	8	4
	20	20	10
	30	29	14
	40	38	18
	50	52	22
	60	59	24
	70	64	26
	80	72	30
	90	84	34
	100	95	38
	110	106	40
	120	112	42
	130	120	42
	140	125	42
BPW-NoP-15x5	10	7	3
	20	11	6
	30	22	9
	40	33	14
	50	46	18
	60	57	22
	70	65	28
	80	73	34
	90	88	38
	100	98	42
	110	106	46
	120	122	56
	130	150	66
	140	177	78
BPW-NoP-20x5	10	11	3
	20	24	6
	30	38	9
	40	54	13
	50	71	17
	60	87	21
	70	103	25
	80	120	29
	90	163	40
	100	190	46
	110	218	52
	120	245	58
	130	259	64
	140	299	80

Model	Number of Plates	HP Removed	Max Oil Flow GPM
BPW-NoP-15x10	10	14	8
	20	30	16
	30	46	26
	40	63	34
	50	76	40
	60	90	46
	70	106	54
	80	122	64
	90	150	74
	100	163	80
	110	177	90
	140	204	100
	170	231	110
	200	259	120
BPW-NoP-20x10	10	19	4
	20	41	8
	30	68	12
	40	90	16
	50	112	20
	60	141	26
	70	171	34
	80	212	44
	90	245	54
	100	286	60
	110	313	66
	140	381	80
	170	449	90
	200	517	95
BPW-NoP-28x10	20	54	10
	40	109	20
	60	177	30
	80	231	40
	100	313	60
	120	408	80
	140	490	100
	160	585	120
	180	694	150
	200	789	180
	220	898	220
	240	966	220
	260	1088	260
	280	1361	310
280	1497	350	

Based on 100 SSU Oil, 40°F Approach Temperature, 2:1 Oil-Water Flow Ratio
NoP = Number of Plates

Accessories

All dimensions are inches unless noted otherwise.

BP Series accessories meet the same high standards as our BP Series line of heat exchangers. The high-quality materials are carefully chosen for compatibility, while the accurate dimensions save you time and money on installation. With TTP accessories you have the assurance that everything will fit – and perform – the way the design engineers intended.



Counter Flanges

To increase the flexibility for units with standard threaded connections, TTP offers a range of compact flanges. The threaded part is easily assembled to the connections and the counter flange welded to your pipe.

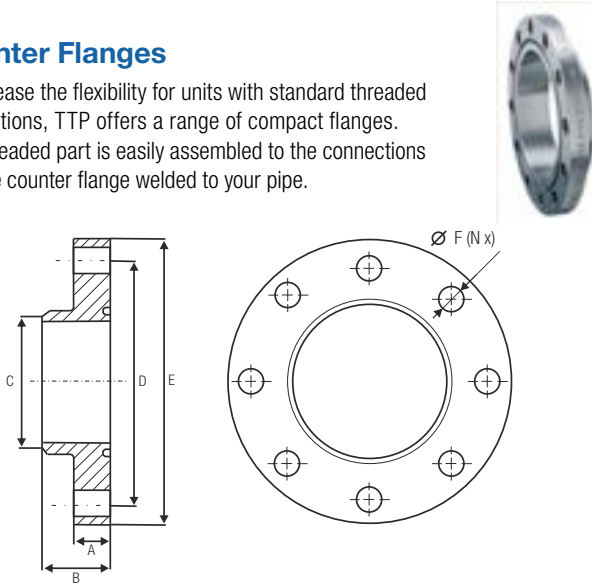

Dimensions

Part No.	Size	A	B	C	D	E	F
56811	DN20C	.39	.79	1.06	2.09	2.80	.43
56812	DN25C	.39	.79	1.33	2.48	3.31	.51
56813	DN50C	.47	.94	2.37	3.58	4.41	.51
56814	DN65C	.47	.94	3.00	4.17	4.91	.51
56815	DN80C	.59	1.18	3.50	4.65	5.55	.51
56816	DN100C	.59	1.18	4.50	5.67	6.50	.51
56817	DN150C	.87	1.73	6.63	8.54	9.84	.51

Ratings (according properties of gasket)

Maximum Working Pressure	580 psi
Minimum Working Temperature	5°F
Maximum Working Temperature	392°F

Materials

Stainless Steel

Carbon Steel flanges available. Consult factory for additional information.

Standard Connections

TTP counter flanges are used to connect your pipe to our compact flanges on the BPHE unit.

Flange Kits

To increase the flexibility for units with standard threaded connections, TTP offers a range of compact flange kits. The threaded part is easily assembled to the connections and the counter flange welded to your pipe.

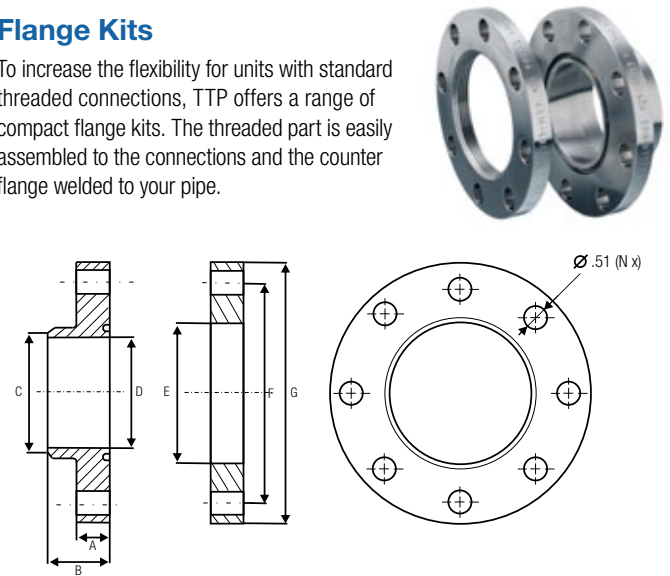

Dimensions

Part No.	Size	A	B	C	D	E	F	G	N
56818	2"	.47	1.46	DN50	1.54	G2"	3.58	4.41	.31
56819	2½"	.47	1.46	DN65	2.36	G2½"	4.17	4.92	.31

Ratings (according properties of gasket)

Maximum Working Pressure	580 psi
Minimum Working Temperature	5°F
Maximum Working Temperature	392°F

Materials

Stainless Steel

Carbon Steel flanges available. Consult factory for additional information.

Standard Connections

Screw-on flanges are used to convert our ISO-G connections to weld neck compact flanges.



Modulating Water Valves and Bulb Wells

These modulating valves regulate the flow of water to the heat exchanger to maintain a desired exiting oil temperature. They open automatically when temperature increases at the sensing bulb. **No** external power source is required to actuate the valve. **Not** to be used for salt water service.

Bulb Wells are used in conjunction with Remote Bulb Temperature Controls where bulb insertion into a vessel or container to sense temperature is required. Standard and custom bulb well lengths available.

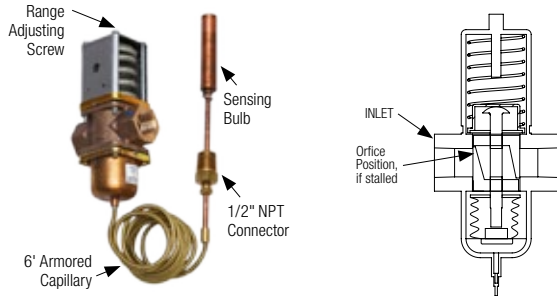

Part No.	Pipe Size (NPT)	Range (Opening Point)	Sensing Bulb Size Diameter x Length	Maximum Water Flow (GPM)	Bulb Well Recommended Size
65293	1/2"	115°F - 180°F	1/16" x 3 3/4"	25	L-65140
65127	3/4"	115°F - 180°F	1/16" x 3 3/4"	40	L-65140
65128	1"	115°F - 180°F	1/16" x 6"	55	L-65141
65146	1 1/4"	115°F - 180°F	1/16" x 6"	75	L-65141
65511	1/2"	75°F - 135°F	1/16" x 10"	25	L-65280
65253	3/4"	75°F - 135°F	1/16" x 10"	40	L-65280
65254	1"	75°F - 135°F	1/16" x 16 1/4"	55	L-67438
65255	1 1/4"	75°F - 135°F	1/16" x 16 1/4"	75	L-67438
66100	1 1/2" ASME	75°F - 115°F	1/16" x 16 1/4"	90	L-67438
67173	2" ASME	75°F - 115°F	1/16" x 43"	150	L-67808

Working pressure to 150 PSI Maximum. *For additional protection of the bulb well stem, use the next longer bulb well.

ADJUSTMENT: 1/2" to 1 1/4" valves can be adjusted with a screwdriver, 1 1/2" and 2" have a 1/2" square shaft. Turn the adjusting screw clockwise to **decrease** opening temperature; and counterclockwise to **increase** opening temperature. Valves are not calibrated, so final desired temperature setting must be established experimentally. Valve is fully open 36°F above opening point.

Water Valve Specifications

Part No.	By-Pass Orifice Diameter	Maximum Bulb Temperature	Opening Temperature (Factory Setting)
65293	.062"	200°F	135°F
65127	.062"	200°F	135°F
65128	.093"	200°F	135°F
65146	.093"	200°F	135°F
65511	.062"	155°F	103°F
65253	.062"	200°F	135°F
65254	.062"	200°F	135°F
65255	.093"	200°F	135°F
66100	.093"	200°F	135°F
67173	.062"	155°F	103°F

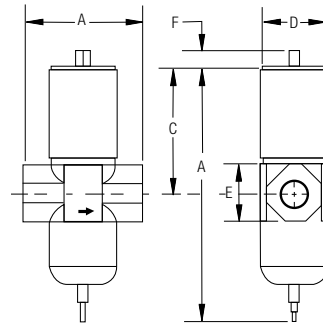

Standard temperature elements are furnished with 6' capillary. Longer capillary lengths not available. Valve Disc: Buna N in brass disc retainer.

Water Valve Dimensions

Valve Size	A	B	C	D	E	F
1/2"	3 1/4	7	3 3/8	1 27/32	1 1/2	1 1/32
3/4"	3 3/16	7 29/64	3 51/64	2 1/32	1 3/4	1 12/32
1"	4 27/32	10 13/16	5 31/64	2 5/8	2	1/2
1 1/4"	4 59/64	10 37/64	5 43/64	2 5/8	2 5/8	1/2
1 1/2"	5 1/16	10 37/64	5 43/64	2 5/8	See flange specs	1/2
2"	6 3/8	12 39/64	6 15/32	3 1/2		1/2

Flange Specifications

Valve Size	# of Bolt Holes	Bolt Hole Size	Bolt Circle	Flange Diameter
1/2"	4	5/8	3 3/8	5
2"	4	3/4	4 3/4	6

Bulb Wells

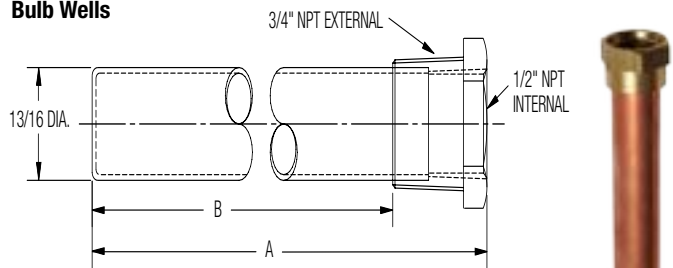

65187 Half Coupling - Mount to Reservoir. For use with all bulb wells shown above.

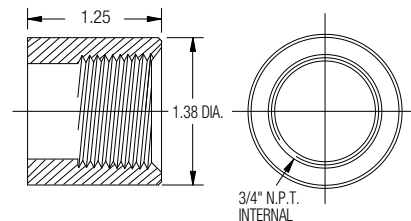

Bulb Well Dimensions

Part No.	A	B
65140	4 15/32	3 15/32
65141	7 1/32	6 7/32
65280	11 7/32	10 7/32
67438	17 15/32	16 15/32
67808	44 3/8	43 3/8

Custom Bulb Well lengths available. Consult factory for additional information.

Materials

Tube Copper
Fitting Brass

Water Strainers

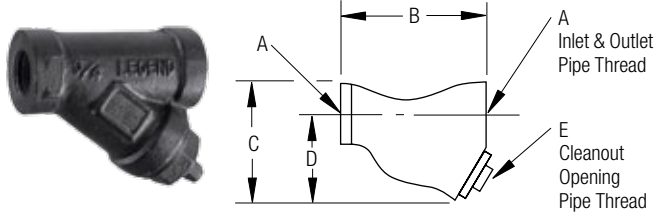

Dimensions

Part No.	A NPT	B	C	D	E
65294	¾	3.08	2.52	1.88	¼
65295	½	3.08	2.52	1.88	¼
65296	¾	3.87	3.07	2.32	¼
65297	1	4.44	3.77	2.81	¾
65301	1¼	5.25	4.32	3.18	¾
65302	1½	6.25	5.10	3.77	½
65303	2	7.63	6.25	4.65	½

Rating

Maximum Working Pressure 300 psi

Materials

Housing Bronze
Screen 20 Mesh, 304 Stainless Steel Wire

COSD Connection for Soldering

For standard thread-connections of TTP BPHE, the welding sleeve with union nut can be used to connect pipes with the connection of the heat exchanger. According to the quality of the used medium, the welding sleeve can be chosen in carbon or stainless steel. The soldering connection consists of a union nut, a gasket and a soldering sleeve. COSD connections are suitable for refrigerant applications.

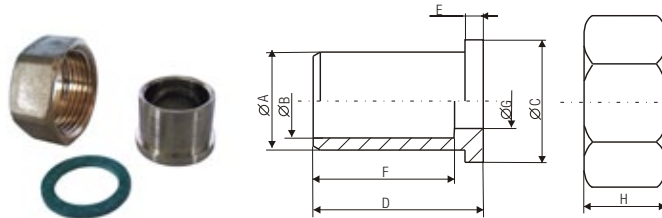

Dimensions

Part No.	Nominal diameter	A	B	C	D	E	F	G	H	Opening of the spanner
56831	¾"	.86	.71	.94	.67	.12	.57	.59	.63	1.18
56832	1"	1.02	.87	1.18	.75	.12	.59	.75	.67	1.42
56833	1¼"	1.38	1.10	1.52	.98	.12	.79	.98	.71	1.81
56834	2"	1.90	1.65	2.20	1.26	.16	1.02	1.54	.94	2.56
56835	2½"	2.36	1.13	2.83	1.46	.19	1.22	2.00	1.02	3.35

The used gasket has a thickness of .079" (2mm)

Materials

Union nut MS58
Soldering sleeve Rg5
Gasket Hecker-Centellen WS 3820

Mounting Bracket

Optional Foot Mounting Bracket (except 8x3 plates). Constructed of Carbon Steel.

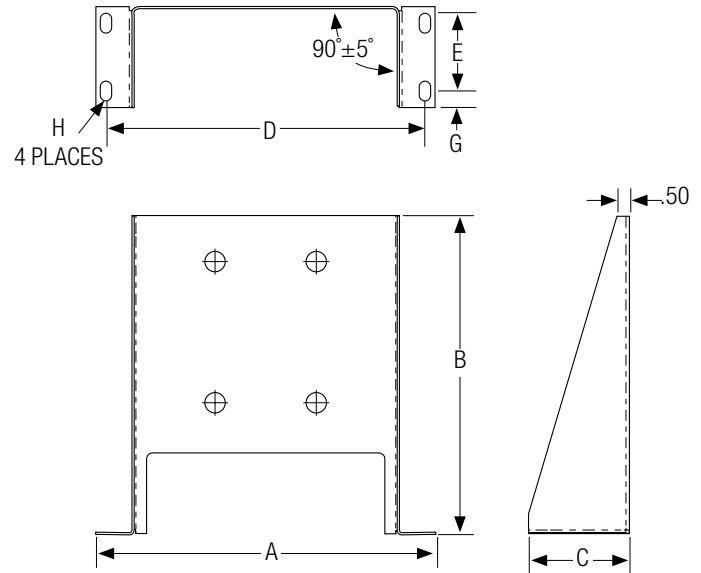
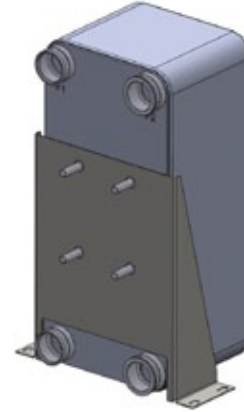

Part No.	Plate Size	A	B	C	D	E	G	H
56839	12x5	7.99	9.35	3.15	7.17	1.77	0.69	.40 x .59
56840	20x5	7.99	15.65	3.15	7.17	1.77	0.69	.40 x .59
56841	15x5	7.99	12.74	3.15	7.17	1.77	0.69	.40 x .59
56842	15x10	13.20	12.40	3.94	12.40	2.64	0.65	.40 x .75
56843	20x10	13.51	14.37	3.94	12.72	2.64	0.65	.40 x .75
56844	28x10	13.20	21.30	3.94	12.40	2.64	0.65	.40 x .75

All dimensions are in inches, unless noted otherwise.

Mounting bracket for location purposes only. Bracket is not designed to support entire weight of the cooler. Customer to add extra support if necessary.

Thermal Bypass Assembly

This thermal bypass valve is ideally suited for hydrostatic drive circuits which require fast warm-up, controlled fluid temperature, and low return line back pressure. When installed in the return line of a hydraulic circuit that employs an oil cooler, this device will modulate fluid temperature by either shifting return line flow through the cooler, or bypassing directly to the reservoir. In addition, a built-in pressure relief function automatically relieves excess pressure to the reservoir should the cooler become restricted and resultant pressure drop become too high for the cooler circuit.

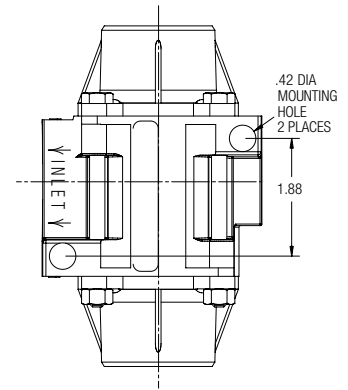
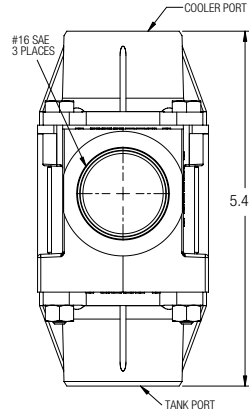
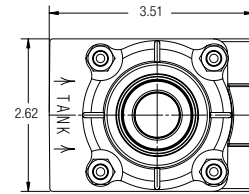

Standard Shift Temperatures

100°F (38°C) 120°F (49°C) 140°F (60°C) 160°F (71°C)

Full Shift (Cooler Port Open) Temperatures

Shift temperature plus 25°F (14°C)

Relief Valve Setting 65 psi (4.5 bar) Consult factory for other pressure settings.

Maximum Operating Pressure 250 psi (17 bar)

Proof Pressure 300 psi (21 bar)

Minimum Burst Pressure

Up to the full shift temperature: 325 psi (22 bar).

Above the full shift temperature: 600 psi (41 bar).

Minimum Operating Temperature -30°F (-34°C)

Maximum Operating Temperature Shift temperature plus 75°F (24°C)

Maximum Flow Rating 60 gpm (227 l/m)

Leakage @ 250 psi (17 bar) and 60 gpm (227 l/m) Inlet Flow

Cooler Port:

- 0.5 gpm (2 l/m) maximum up to 5°F (3°C) before shift temp.
- 1.0 gpm (4 l/m) maximum from 5°F (3°C) before shift to shift.

Tank Port: 0.10 gpm (0.4 l/m) maximum

Operating Fluid Mineral base hydraulic fluids

Construction Aluminum die-cast housing

Part No.	A
65654	100°F (38°C)
65655	120°F (49°C)
65655	140°F (60°C)
65655	160°F (71°C)

Operating Characteristics

- Mode 1: At temperatures below the shift temperature oil flows from inlet to tank port.
- Mode 2: At temperatures between the start of shift and full shift the flow from the inlet port is divided between the cooler and tank ports.
- Mode 3: At temperatures above the full shift temperature inlet flow is through the cooler port.
- Mode 4: At temperatures above the full shift temperature the excess pressure is relieved through the tank port.

For 120°F Shift Temperature

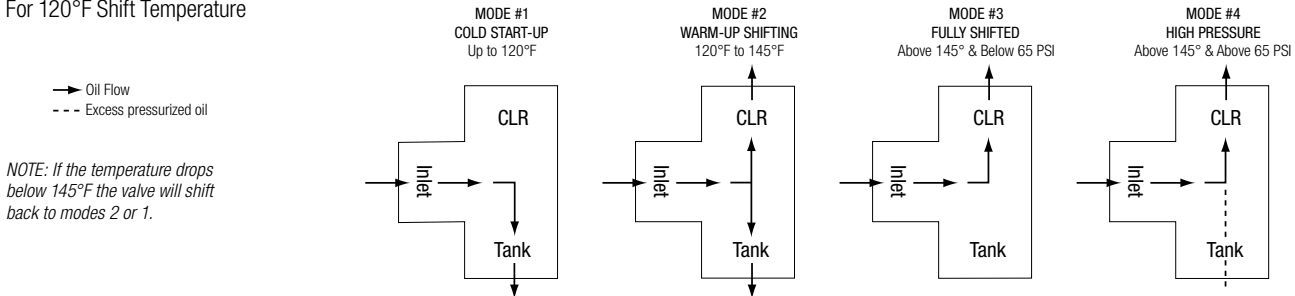

Pressure Drop (Mobile DTE 26 OIL)

Inlet Port Thru Tank Port @ 100°F (300 SUS)

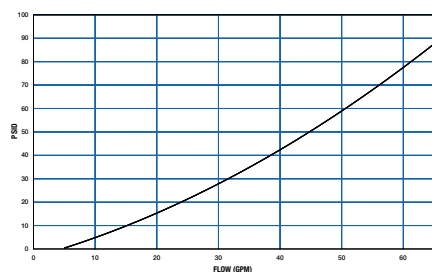

Inlet Port Thru Cooler Port @ 145°F (110 SUS)

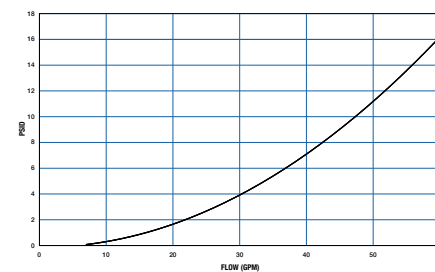

Inlet Port Over Integral Relief Valve @ 170°F (78 SUS)

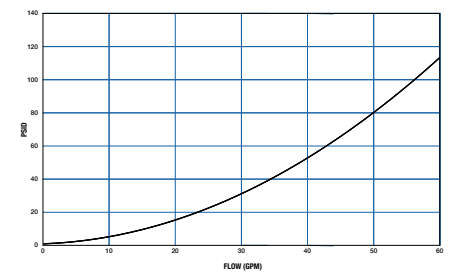

NOTE: Pressure drop shown is added to relief valve crack pressure for total pressure drop.

Three-Way Thermostatic Valves

TTP thermostatic valves use the principle of expanding wax. A self-contained power element activates a stainless steel sliding valve that provides a positive three-way valve action. All temperature settings are factory set. Elements are field replaceable to obtain the same, or a new bypass temperature setting. Valves may be installed for either mixing or diverting modes of operation at the preference of the user. They may be mounted in any plane. Valves are acceptable for oil or water service.

Rating

Maximum Operating Pressure 125 psi

Materials

Housing Grey Iron (*Steel or Bronze optional*)

O-Ring Seals Viton (*Buna N optional*)

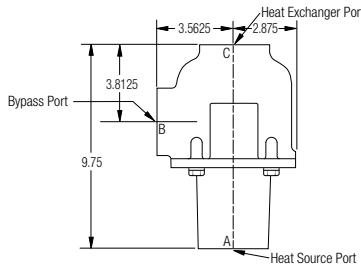
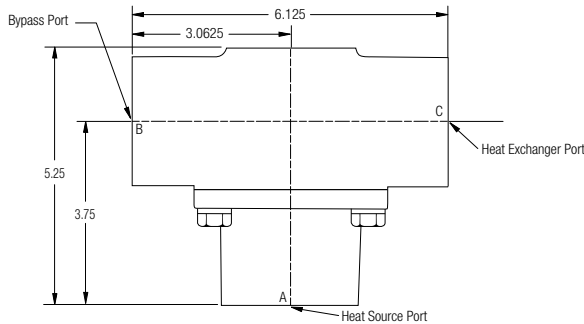
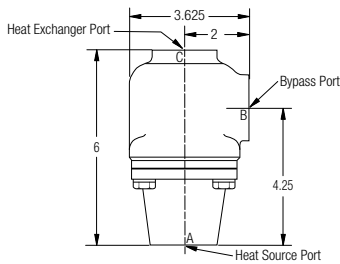

Pressure Drop Curves

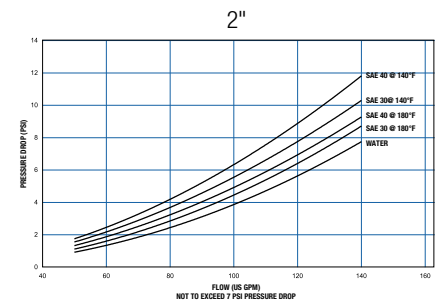
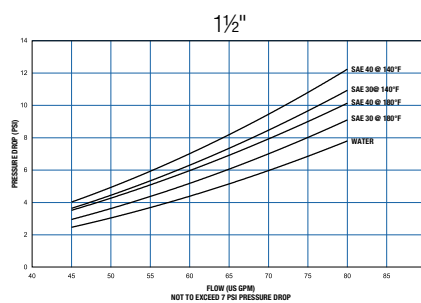
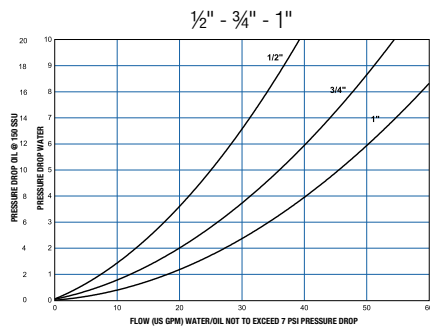

Part No.	Port Size
66037-110°F	1/2" NPT
66037-140°F	1/2" NPT
66038-110°F	3/4" NPT
66038-140°F	3/4" NPT
66039-110°F	1" NPT
66039-140°F	1" NPT
67365-110°F	#16 SAE
67365-140°F	#16 SAE
66040-110°F	1-1/2" NPT
66040-140°F	1-1/2" NPT
67760-110°F	#24 SAE
66041-105°F	2" NPT
66041-140°F	2" NPT

NOTE: All three ports on any one valve have the same thread size.

Special Temperature Ranges

1/2"-3/4"-1" NPT Part No.	1 1/2" NPT Part No.	2" NPT Part No.
65974	65977	65978
65975	66040	66041
65976	67760	
66037	(#24 SAE)	
66038		
66039		
67365		
(#16 SAE)		

NOTE: All three ports on any one valve have the same thread size.

1/2"-3/4"-1" NPT		1 1/2" NPT		2" NPT	
Nominal	Temp. Range	Nominal	Temp. Range	Nominal	Temp. Range
80	77-88	80	70-88	75	70-85
90	80-100	90	80-100	90	85-105
110	100-120	110	100-120	105	100-116
120	110-130	120	110-130	120	110-130
130	120-140	130	120-140	130	124-140
140	130-150	140	130-150	140	135-150
150	140-160	150	140-160	150	145-160
160	150-170	160	150-170	155	150-165
170	163-180	170	163-180	160	155-172
185	175-190	175	170-185	165	160-175
195	185-200	180	175-190	170	165-180
200	190-210	190	185-200	180	175-190
		200	190-210	195	188-208
				210	200-215

EXAMPLE: 1" NPT, Part Number 66039-90 indicates the 1" NPT valve with a nominal shift temperature of 90°F. The actual operating temperature range in this example is 80-100°F. The valve begins to open at 80°F, and is fully open at 100°F.

Insulation

Insulation boxes for heating applications.

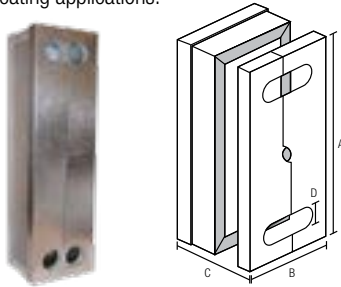

Dimensions

Part No.	A	B	C* (Approx.)	D	Thickness
56820	9.33	4.72	1.26 + .09 x NoP	1.18	.79
56821	13.11	6.38	2.00 + .09 x NoP	1.97	.79
56822	16.61	6.46	2.13 + .09 x NoP	1.97	.79
56823	16.61	6.46	2.17 + .09 x NoP	1.97	.79
56825	17.28	11.34	2.17 + .10 x NoP	3.54	.79
56826	22.52	11.34	2.68 + .09 x NoP	3.54	.79
56827	22.52	11.34	2.17 + .10 x NoP	3.54	.79

*Only available in selected 20th NoP (20, 40, 60, etc). NoP = Number of Plates.

Rating

Maximum Working Temperature	302°F
Thermal Conductivity	0.013 BTU/HrFtF°
Fire Properties	B2 in accordance with DIN 4102
Color	Silver

Materials

Insulation	Polyurethane rigid foam
Insulation Cover	Aluminum

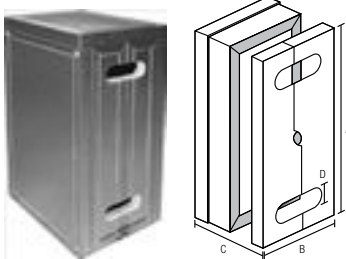

Dimensions

Part No.	A	B	C* (Approx.)	D	Thickness
56828	26.78	18.11	9.13 + .09 x NoP	3.15	1.97
56829	37.80	17.32	9.84 + .10 x NoP	3.35	1.97
56830	27.95	18.90	10.24 + .09 x NoP	3.74	1.97

*Only available in selected 20th NoP (20, 40, 60, etc). NoP = Number of Plates.

Rating

Maximum Working Temperature	302°F
Thermal Conductivity	0.014 BTU/HrFtF°
Fire Properties	B2 in accordance with DIN 4102
Color	Silver

Materials

Insulation	Rigid expanded polyurethane
Insulation Cover	Aluminum

Please read carefully before attempting to assemble, install, operate or maintain the product described. Protect yourself and others by observing all safety information. Retain instruction for future reference.



GENERAL INFORMATION

Depending on material combinations, pressure ratings and functions, there are several different types of compact Brazed Plate Heat Exchangers (BPHEs). The standard materials are stainless steel, vacuum-brazed with a pure copper or nickel-based filler.

The basic materials of construction indicate the type of fluids that TTP's BPHEs can be used with. Typical examples are: synthetic or mineral oil, organic solvents, water (not seawater), glycol mixtures (ethylene and propylene glycol).

The front plate of TTP's BPHE is marked with an arrow. The purpose of this marker is to indicate the front side of the BPHE and the location of the inner and outer circuits/channels. With the arrow pointing up, the left side (Port F1, F3) is the inner circuit and the right side (Port F2, F4) is the outer circuit. For TTP asymmetric products one circuit is narrow while the other is wide, which makes it additionally important to correctly combine flow and circuit to reach design performance.

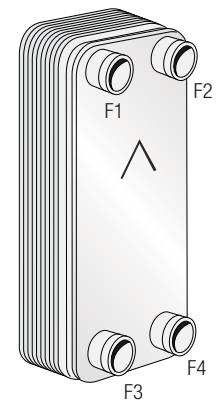

Ports F1/F2/F3/F4 are situated on the front of the heat exchanger.

DESIGN CONDITIONS

The standard pressure rating used for TTP BPHEs, i.e. for standard operating pressure, is maximum 450 psi (3.1 MPa). TTP offers a wide range of pressure ratings based on applications, from low pressures (116 psi) up to high pressures (2030 psi). TTP's standard maximum operating temperature is 437°F for copper-brazed BPHEs, and 660°F for Nickel brazed BPHEs. However, as temperature and pressure are closely coupled, there is a possibility to increase the pressure if the temperature is reduced. For details, please check the label and other technical documentation.

Installation & Maintenance

MOUNTING

Never expose the unit to pulsations or excessive cyclic pressure or temperature changes. It is also important that no vibrations are transferred to the heat exchanger. If there is a risk of this, install vibration absorbers. For large connection diameters, we advise you to use an expanding device in the pipeline. It is also suggested that e.g. a rubber mounting strip should be used as a buffer between the BPHE and the mounting clamp.

In single-phase applications, e.g. water-to-water or water-to-oil, the mounting direction has little or no effect on the performance of the heat exchanger.

CONNECTIONS

Allowable Connection Loads for Pipe Assembly Conditions

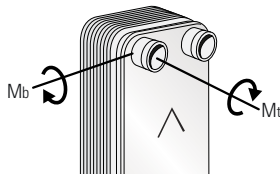

The maximum allowable connection loads given below are valid for low cycle fatigue. If high cycle fatigue is involved special analysis should be made.

Allowable connection loads for different pipe assembly conditions

Pipe Size	Shear Force, F_s (lbf)	Tension Force, F_t (lbf)	Bending Moment, M_b (lbf*in)	Torque, M_t (lbf*in)
½"	787	562	177	310
¾"	2698	562	177	1018
1"	2518	899	398	1372
1¼"	3260	1461	774	2345
1½"	3709	2136	1372	3098
2"	4833	3035	2257	5310
2½"	10004	4047	3452	12834
3"	12447	4136	5089	21773

Allowable Loads for Stud Bolt Assembly Conditions

Mounting stud bolts, in different versions and locations, are available on the BPHEs as an option. These stud bolts are welded to the unit. The maximum allowable load on the stud bolts during assembly are stated below.

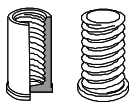

Allowable loads for different stud bolt assembly conditions:

Stud Bolt	Stress Area A_s (in ²)	Tension Force F_t (lbf)	Torque M_t (lbf*in)
M6	0.032	315	27
M8	0.053	585	71
M12	0.144	1349	239

INSTALLATION OF BPHEs IN DIFFERENT APPLICATIONS

Single-Phase Applications

Normally, the circuit with the highest temperature and/or pressure should be connected on the left side of the heat exchanger when the arrow is pointing upwards. For example, in a typical water-to-water application, the two fluids are connected in a counter-current flow, i.e. the hot water inlet in connection F1, outlet F3, cold water inlet F4, outlet F2. This is because the right-hand side of the heat exchanger contains one channel more than the left-hand side, and the hot medium is thus surrounded by the cold medium to prevent heat loss.

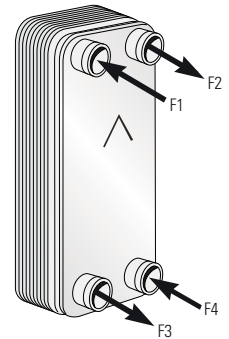

WATER STRAINER

A water strainer should be installed in the water inlet to protect the unit from particulate matter. 16-20 mesh minimum (20-40 mesh best choice).

PIPING

Piping must be properly supported to prevent excess strain on the heat exchanger ports. Stainless steel is typically not satisfactory for salt water service.

CLEANING

In some applications, the fouling tendency could be very high; for example when using extremely hard water. It is always possible to clean the exchanger by circulating a cleaning liquid. Use a tank with a weak acid. 5% phosphoric acid, or if the exchanger is frequently cleaned, 5% oxalic acid. Pump the cleaning liquid through the exchanger. For optimum cleaning, the cleaning solution flow rate should be a minimum of 1.5 times normal flow rate, preferably in a backflush mode. Afterwards rinse with large amounts of fresh water in order to get rid of all the acid before starting up the system again. Clean at regular intervals.

STORAGE

BPHEs are to be stored dry. The temperature should not be below 34°F and not over 122°F for long term storage (more than 2 weeks).

DISCLAIMER

TTP's BPHE performance is based on installation, maintenance and operating conditions done in conformance with these instructions. TTP cannot assume any liability for BPHEs that do not meet these criteria.

The heat exchanger is not type-approved for fatigue loading.

We **COOL** what you **POWER**

ttsales@apiheattransfer.com

www.thermaltransfer.com

Thermal Transfer Products

5215 21st Street

Racine, Wisconsin 53406-5096 USA

+1.262.554.8330

API Heat Transfer

PERFORMANCE IS EVERYTHING

API Heat Transfer Inc. is a global leader in the design and manufacture of a wide range of specialty heat exchangers and heat transfer solutions. Customers benefit from the industry's broadest specialty heat-exchanger portfolio, best-in-class product development and testing capabilities, and an unmatched global sales and manufacturing infrastructure.

For more information visit www.apiheattransfer.com.

- Global headquarters in Buffalo, NY
- Trusted partner to customers and provider of standard and custom-engineered heat transfer solutions for over 130 years
- Network of 1,800 employees with sales offices around the world
- Twelve modern manufacturing facilities worldwide
- Six business units providing premium brands and the broadest product portfolio available in today's market

See how our performance can improve yours.

USA

Arcade Facility

91 North Street
Arcade, NY 14009, USA
+1.585.496.5755

Buffalo Facility

2777 Walden Avenue
Buffalo, NY 14225, USA
+1.716.684.6700

Franklin Facility

4700 Ironwood Drive
Franklin, WI 53132, USA
+1.414.761.4500

Iron Ridge Facility

1025 Industrial Road
Iron Ridge, WI 53035, USA
+1.920.387.4200

Montgomery Facility

2760 Gunter Park Dr. West
Montgomery, AL 36109, USA
+1.334.277.1810

Racine Facility

5215 21st Street
Racine, WI 53406, USA
+1.262.554.8330

UK

Birmingham Facility

Seeleys Industrial Park
Seeleys Road, Birmingham
B11 2QY, United Kingdom
+44 (0) 121.766.1350

Coventry Facility

Sir Henry Parkes Road
Canley, Coventry
CV5 6BN, United Kingdom
+44 (0) 24.7667.5544

GERMANY

Bretten Facility

Langenmorgen 4
75015 Bretten, Germany
+49.7252.53.0

Dortmund Facility

Breienbachstrasse 87
44 357 Dortmund, Germany
+49.231.9920.0

CHINA

Suzhou Facilities

156 Qingqiu Street, 3rd District
Suzhou Industrial Park
Suzhou, Jiangsu 215126, China
+86.512.8816.8000

126 Qingqiu Street, 3rd District
Suzhou Industrial Park
Suzhou, Jiangsu 215126, China
+86.512.8816.8000